

DC spark-over voltage ¹⁾²⁾	190 ... 220	V
Initial values		
Ignition time t_i after 150 hours in darkness ³⁾	95 99.9 100	%
at -20 °C	≤ 4	≤ 5 ≤ 7
at +25; 125 °C	≤ 2	≤ 3 ≤ 4
Electrical life time		
Maximum increase of DC spark-over voltage	25	V
Switching operations at +25; 125 °C		
Switching frequency 10 ... 25 Hz	2 000 000	Ignitions
Switching frequency < 10Hz	4 000 000	Ignitions
Test circuit parameters		
Open circuit voltage V_0	230	V_{ac}
Loading resistance R	15	k Ω
Discharge capacitance C	2.2	μ F
Inductance L	10	μ H
Discharge peak current I_p	~ 300	A
Insulation resistance at 100 V_{dc}	> 0.1	G Ω
Capacitance at 1 MHz	< 2	pF
Weight	~ 1.5	g
Operation and storage temperature	-20 ... +125	°C
Climatic category (IEC 60068-1)	20/ 125/ 21	
Marking, red	EPCOS CS 230 YMM O CS - Series 230 - Nominal voltage YY - Year of production MM - Month of production O - Non radioactive	

¹⁾ At delivery AQL 0.65 level II, DIN ISO 2859

²⁾ In ionized mode, after load

³⁾ Time from capacitor charged to the first high voltage spark
 Test circuit: $V_{ac} = 198$ V; $R = 36$ k Ω ; $C = 2.2$ μ F

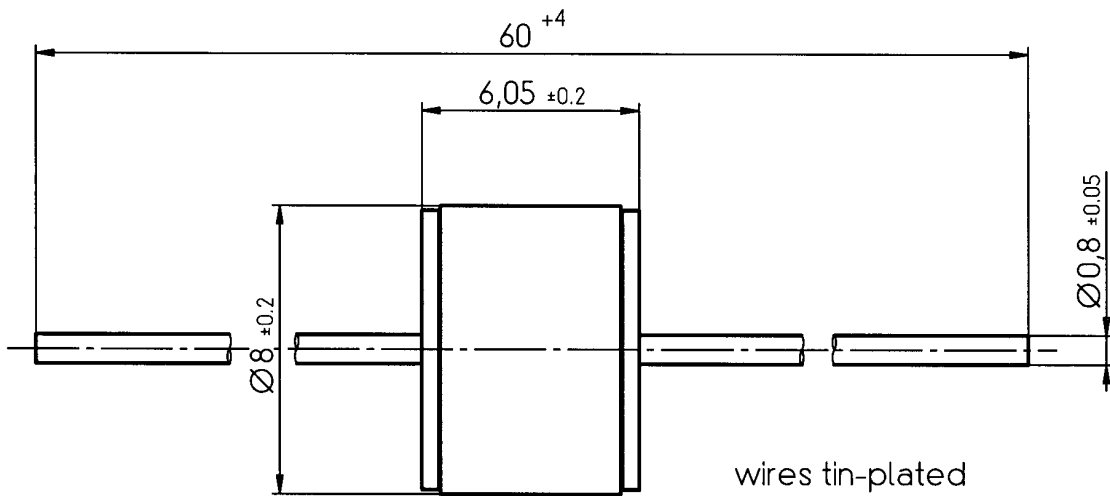

wires tin-plated

Not to scale

Dimensions in mm

Non controlled document

© EPCOS AG 2002. Reproduction, publication and dissemination of this data sheet, enclosures hereto and the information contained therein without EPCOS' prior express consent is prohibited.

Purchase orders are subject to the General Conditions for the Supply of Products and Services of the Electrical and Electronics Industry recommended by the ZVEI (German Electrical and Electronic Manufacturers' Association), unless otherwise agreed.